

Vector Frame Kit 17

VF-K-17

The innovative, contemporary and clean appearance of the Vector Frame™ line of exhibit kits will captivate your audience. Kits feature push-fit fabric graphics, easy-to-assemble extrusion frames, accent lighting, tables, counters, literature accessories, monitor mounts and interior LED edge lighting where indicated.



features and benefits:

- 50mm silver extrusion frame
- Single-sided SEG dye-sublimated push-fit fabric graphics
- Includes four literature racks
- Kit includes frame, five fabric graphic panels, four rigid graphic wing accents, four 120 watt lights, four literature pockets and two wheeled molded cases
- Lifetime hardware warranty against manufacturer defects

dimensions:

Hardware	Graphic
<p>Assembled unit: 221.25" w x 102" h x 27.75" d 5619.75mm(w) x 2590.8mm(h) x 704.85mm(d)</p>	<p>Total visual area: Dye sub Panels: Panels C & G: 50.75" w x 94.5" h 1289mm(w) x 2400mm(h)</p> <p>Panels D & F: 10.25" w x 94.5" h 260mm(w) x 2400mm(h)</p> <p>Panel E: 99.5" w x 94.5" h 2527mm(w) x 2400mm(h)</p>
<p>Shipping</p> <p>Shipping dimensions - ships in 2 cases: Two OCH2 cases: 52" l x 30" w x 15" h 1320.8mm(l) x 762mm(w) x 381mm(h)</p> <p>Approximate shipping weight (entire kit): 179.24 lbs / 81.3 kgs</p>	<p>UV Panels: Panels A, B, H & I: 8.26" w x 45.27" h 210mm(w) x 1150mm(h)</p> <p>Please be sure to include a 2" bleed around the perimeter for dye sub panels and 1/2" bleed around the perimeter for uv panels.</p> <p>Refer to related graphic templates for more information</p>

additional information:

<p>Graphic material: Dye-sublimated fabric, rigid sintra graphics</p>	<p>Lights Included: Lumina 200 120 watt floodlight, curved arm, black finish, 19.5" from end to end</p>
---	---

We are continually improving and modifying our product range and reserve the right to vary the specifications without prior notice. All dimensions and weights quoted are approximate and we accept no responsibility for variance. E&OE. See Graphic Templates for graphic bleed specifications.

Parts Included:

Code	Qty	Description
VF-K-17-A-G	x1	210MM (8.26")W X 1150MM (45.27")H PVC GRAPHIC
VF-K-17-B-G	x1	210MM (8.26")W X 1150MM (45.27")H PVC GRAPHIC
VF-K-17-C-G	x1	1289MM (50.75")W X 2400MM (94.5")H FABRIC GRAPHIC W/FCE-2 ALL SIDES
VF-K-17-D-G	x1	260MM (10.25")W X 2400MM(94.5")H FABRIC GRAPHIC W/FCE-2 ALL SIDES
VF-K-17-E-G	x1	2527MM (99.5")W X 2400MM (94.5")H FABRIC GRAPHIC W/FCE-2 ALL SIDES
VF-K-17-F-G	x1	260MM (10.25")W X 2400MM(94.5")H FABRIC GRAPHIC W/FCE-2 ALL SIDES
VF-K-17-G-G	x1	1289MM (50.75")W X 2400MM (94.5")H FABRIC GRAPHIC W/FCE-2 ALL SIDES
VF-K-17-H-G	x1	210MM (8.26")W X 1150MM (45.27")H PVC GRAPHIC
VF-K-17-I-G	x1	210MM (8.26")W X 1150MM (45.27")H PVC GRAPHIC
F51	x4	8R X 30 DEGREE PHFC2 EXTRUSION - WITH CAM LOCKS BOTH ENDS
F22	x8	1193MM (46.97") PMFC2-90 EXTRUSION - WITH IB2 LOCK HOLES BOTH SIDES
F49	x4	8R PHFC2 EXTRUSION WITH LOCK ONE SIDE - WITH IB2 LOCK HOLES ONE SIDE
F34	x4	1155MM (45.47") PHFC2 EXTRUSION - WITH IB2 HOLE ONE SIDE - WITH LOCK ONE END
VE-75	x4	210MM (8.27") PH EXTRUSION WITH LOCK TWO ENDS
VE-85	x2	1155MM (45.47") LENGTH OF PH1 EXTRUSION - WITH IB2 LOCK HOLES ONE SIDE - SLIDE LOCK ONE SIDE
SW-FOOT	x2	VECTOR FRAME SUPPORT FOOT
IB2	x8	PH INLINE CONNECTOR
CB9-R	x2	50MM ROUND PHCF2 CORNER BRACKET
CB9-S	x2	50MM SQUARE PHCF2 CORNER BRACKET
LUM-200-ORL-B LN-3P-LT-FXT	x4	BLACK 200W HALOGEN LIGHT FIXTURE ETL APPROVED
PMFC2-90-CAP	x8	PMFC2 90 DEGREE EXTRUSION CAP
LN112	x4	A4 UNIVERSAL LITERATURE HOLDER
STS-1	x16	SLIM TRUSS SPACER
CKSO	x4	1" x 1" STANDOFF
PANEL CLAMP	x8	7MM PLASTIC MOLDED PANEL CLAMP

VF-K-17

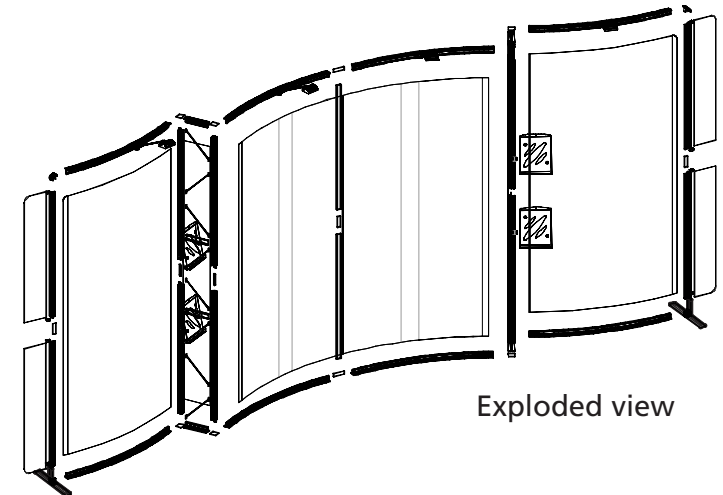
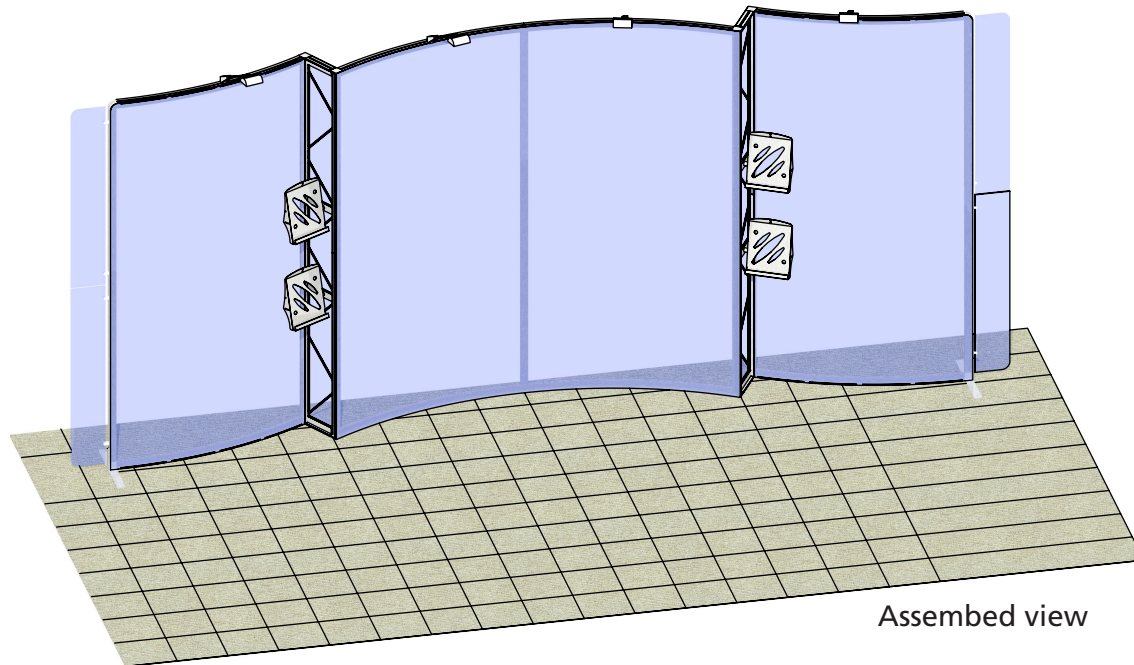
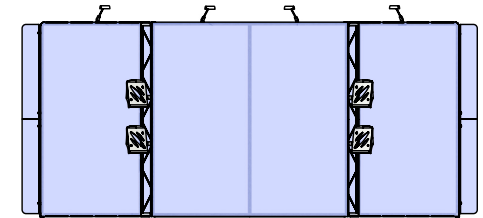

Step 1: Assemble Truss Section

Arrange pieces on the floor as shown in the diagram below. When locking be sure to turn each cam a little bit and then go back and tighten to the proper tension. Take care to turn locks only half a turn. Slide the IB2 into the extrusion to connect sides. Tighten to the proper tension to lock extrusions together.

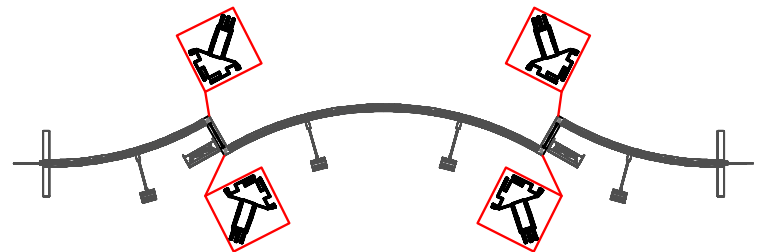
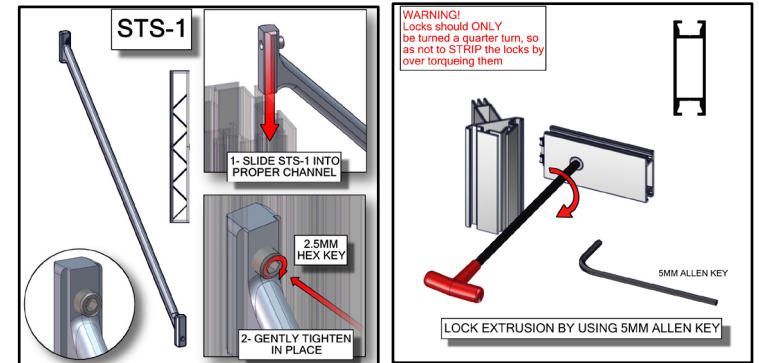
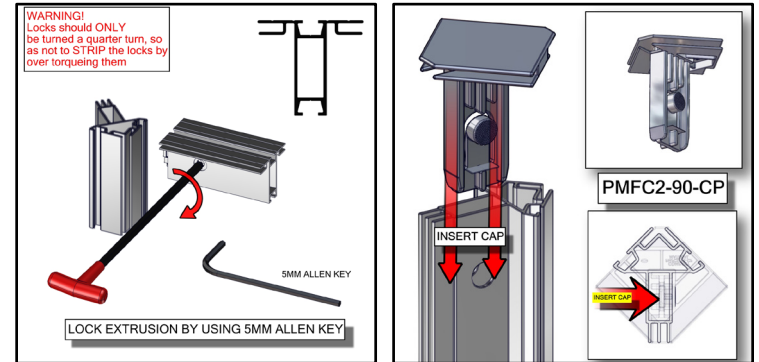
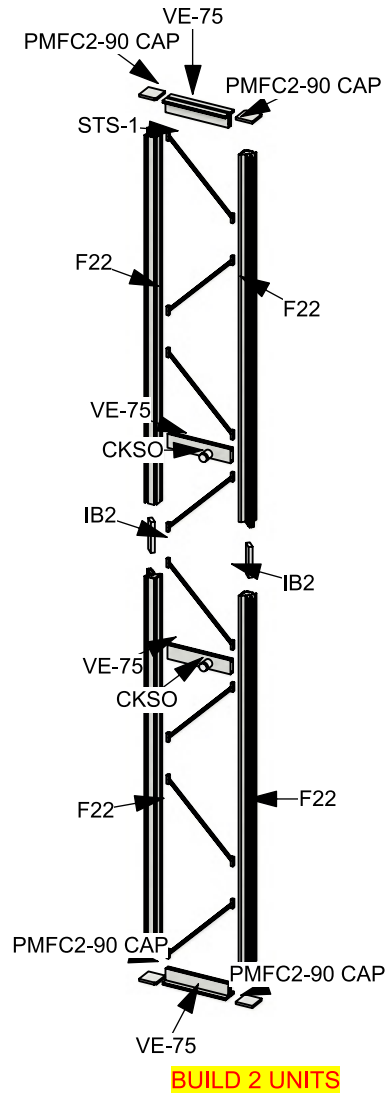
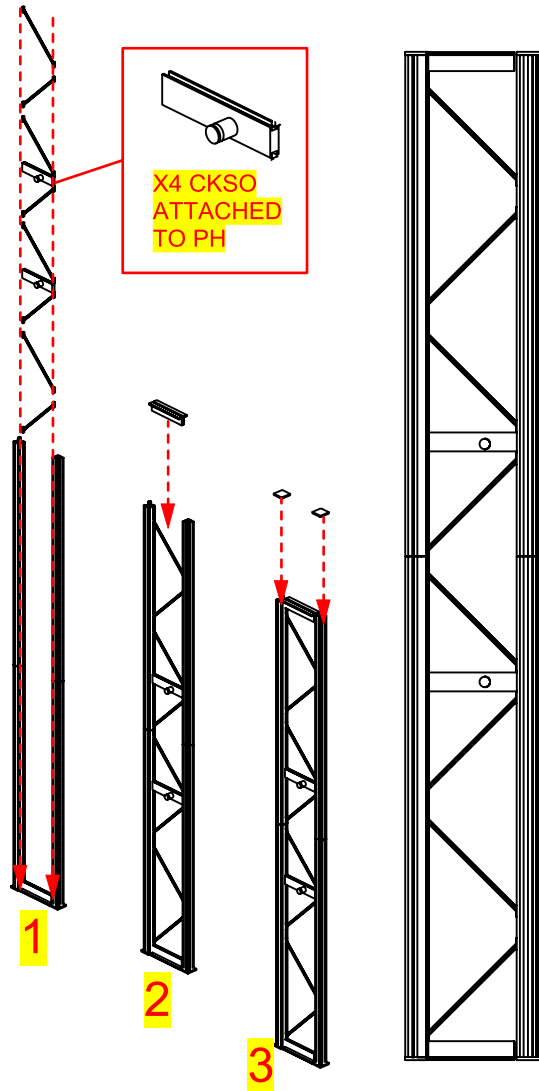

Step 2: Assemble Center Sections

Arrange pieces on the floor as shown in the diagram below. Assemble frame by securing F49 and VE-85s to the truss section. When locking be sure to turn each cam a little bit and then go back and tighten to the proper tension. Take care to turn locks only half a turn. Slide the IB2 into the extrusion to connect sides. Tighten to the proper tension to lock extrusions together. When connecting center sections to truss section, CKSO on truss section should face front, so literature racks will be in front of VF-K-18-D-G.

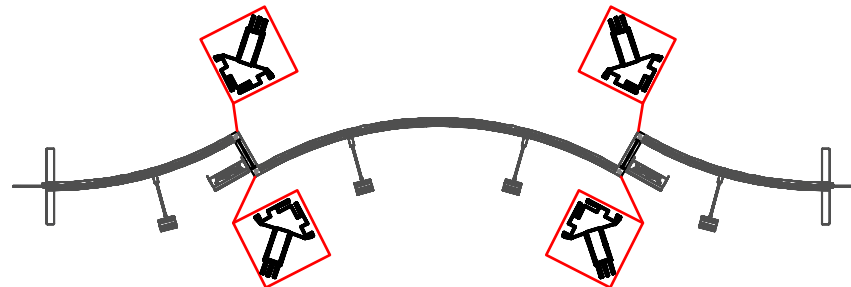
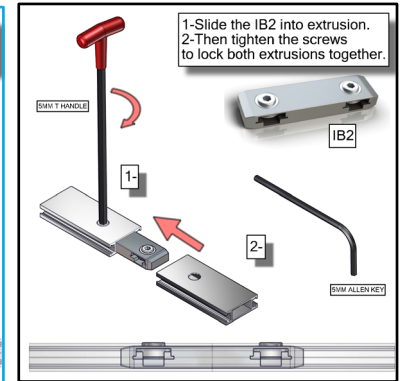
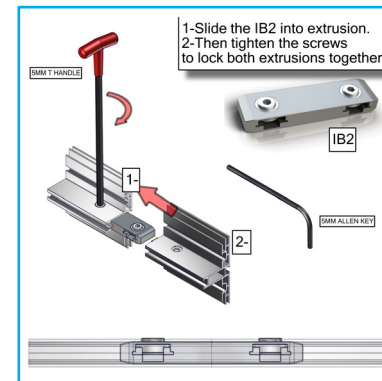
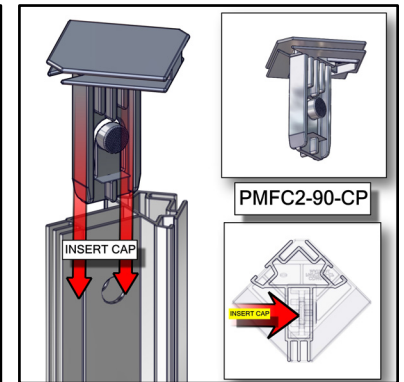
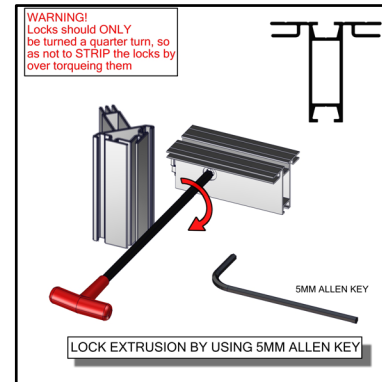
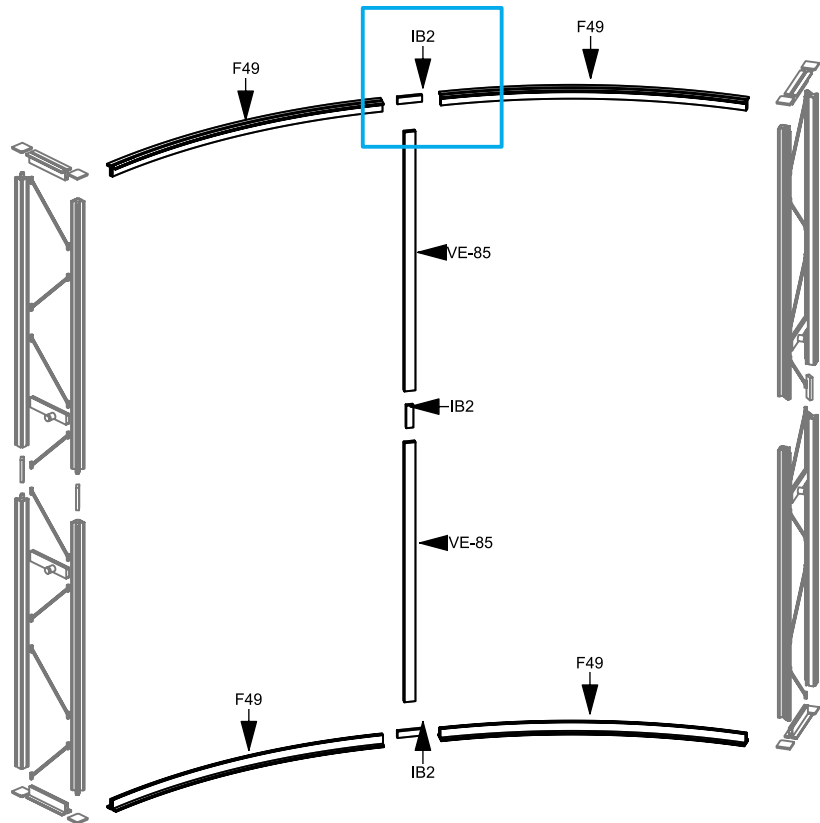

Step 3: Apply Graphics

Install graphic(s) by pressing the FCE-2 edge of graphic into the channel of the extrusion. Start in upper left corner and insert in remaining corners, then push graphic into each side. Assure graphic is tightly inserted. When taking graphics off, take care to gently pull by attached pull tab.

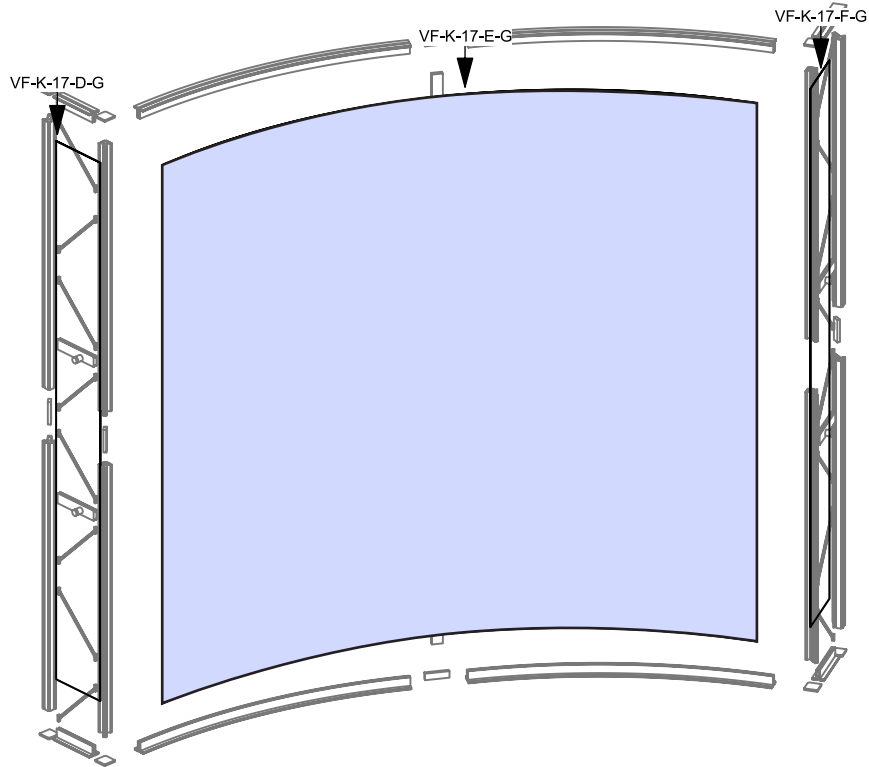
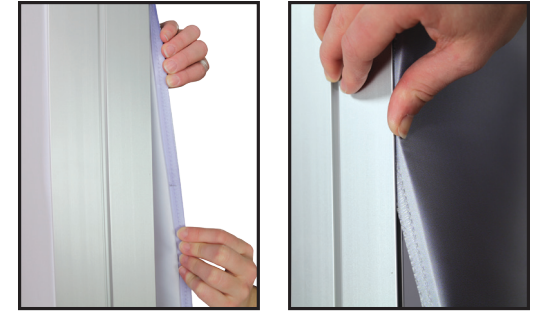

**INSTALL
FABRIC ON THE
BACKSIDE**

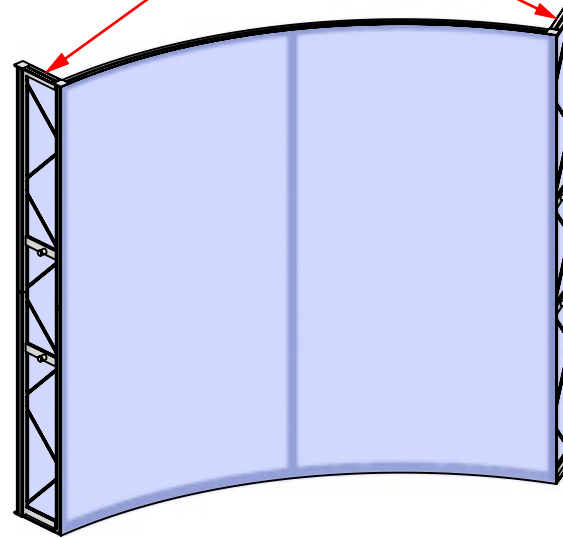

FCE-2 TO PHFC2

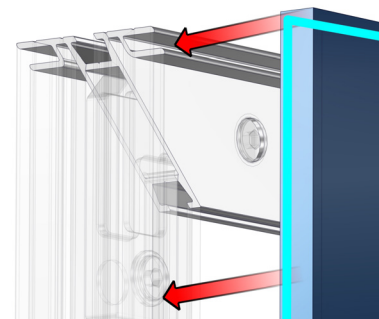

FCE-2 TO PHFC2

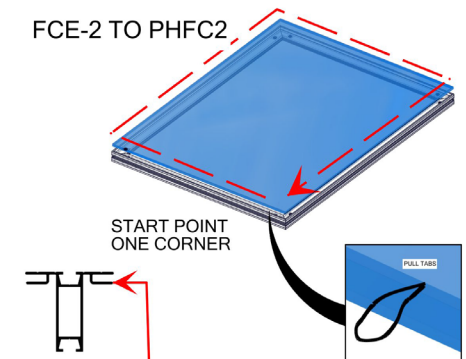

Install graphic by pressing the FCE-2 into the channels of PHFC2 extrusion. To pull graphics out of the channels, use tabs on the front side

Step 4: Assemble Left and Right End Sections

Arrange pieces on the floor as shown in the diagram below. Assemble frame by securing CB9-R on the top and CB9-S on the bottom to F51 and F34s. When locking be sure to turn each cam a little bit and then go back and tighten to the proper tension. Take care to turn locks only half a turn. Slide the IB2 into the extrusion to connect sides. Tighten to the proper tension to lock extrusions together. To adhere foot to frame, loosen thumbscrews from foot. Slide extrusion into LN-100 groove. Tighten to the proper tension to secure supporting feet.

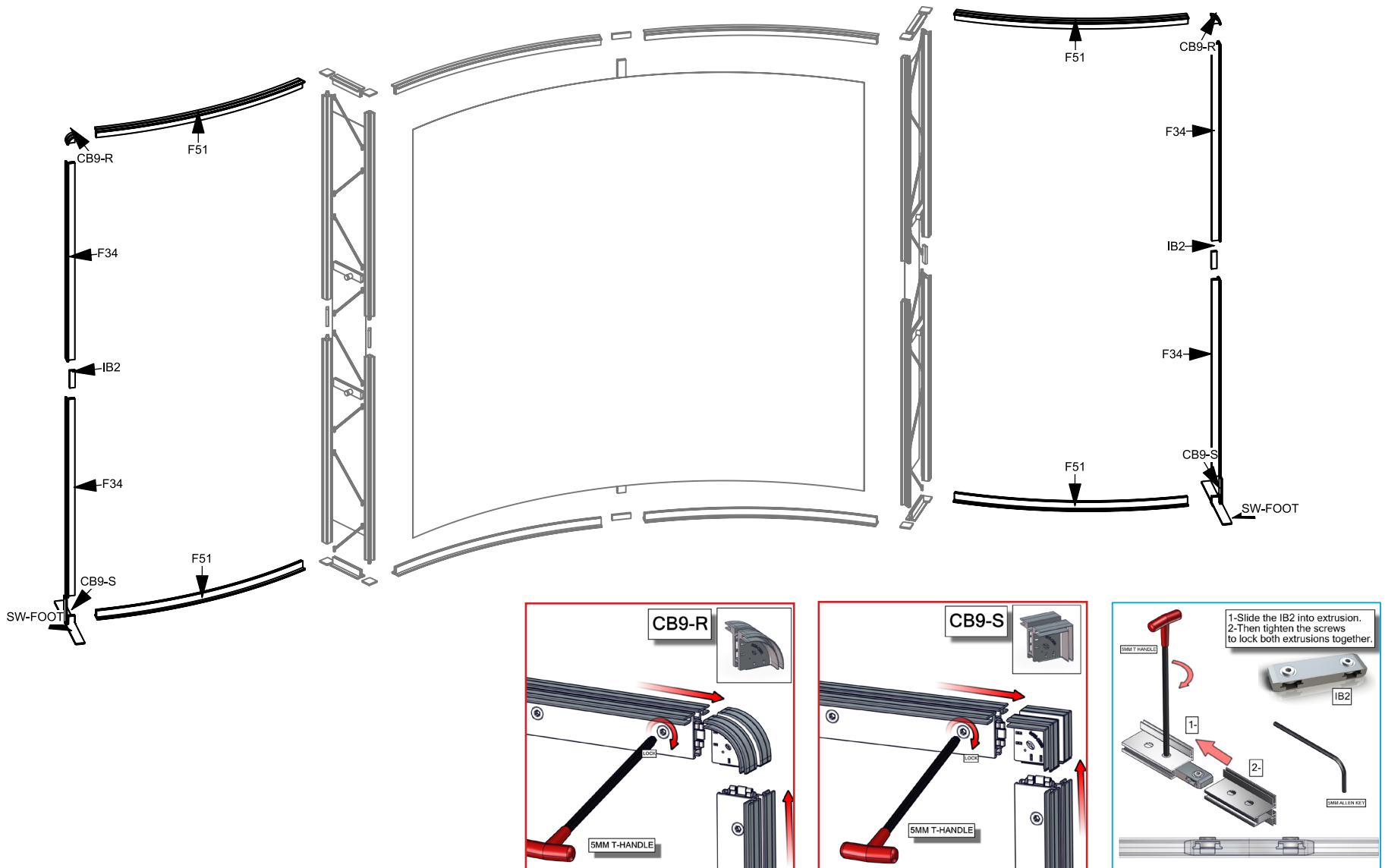

Step 5: Apply Graphics

Install graphic(s) by pressing the FCE-2 edge of graphic into the channel of the extrusion. Start in upper left corner and insert in remaining corners, then push graphic into each side. Assure graphic is tightly inserted. When taking graphics off, take care to gently pull by attached pull tab. To attach accent wings, screw panel clamps clockwise into the channel until tightened. Loosen the thumbscrew. Place rigid sintra graphics into palce and tighten thumbscrew to secure. Overtightening can strip thumbscrew and damage graphic.

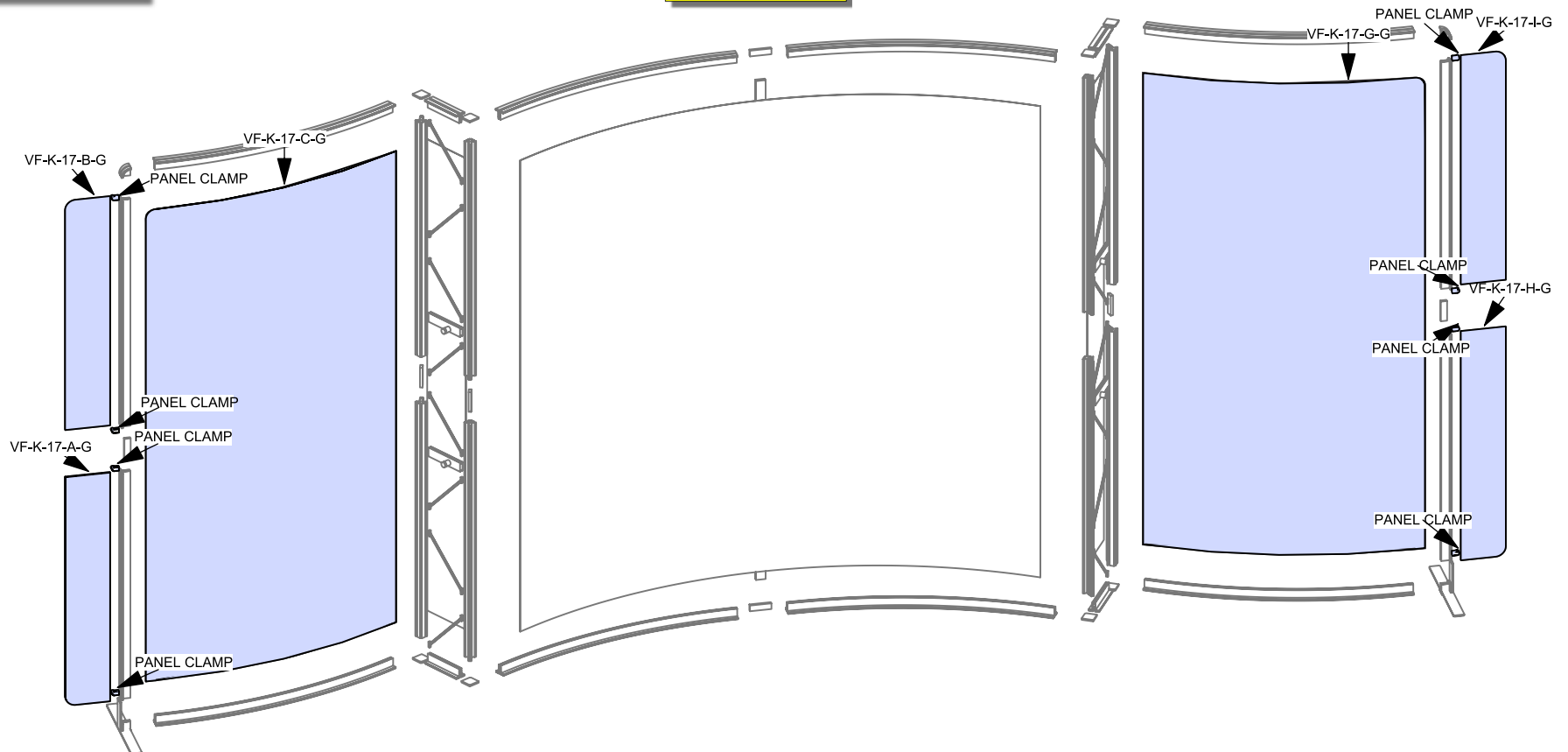
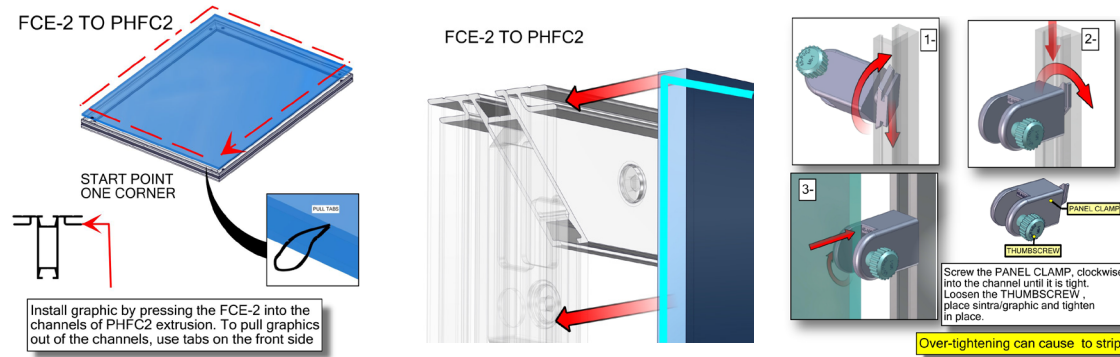
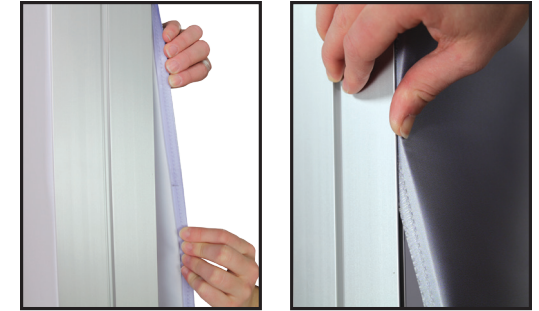

Step 6: Install Literature Racks & Install Lights

To install literature rack, secure LN112 with CKSO cap onto CKSO barrel. Repeat for remaining literature racks. Slide light clip onto each light. Then slide light into the extrusion channel at an angle and gently lower down and repeat for each light.

