

XClaim™

Twenty nine XClaim™ fabric popup display sizes and configurations are available.

XClaim is a versatile stretch fabric popup display system. Add dimension to your event or tradeshow with unique, exciting graphic styles. XClaim is easy to setup, is lightweight and portable. The collapsible popup frame is fully magnetic (with magnetic linking connectors), making it simple to assemble and disassemble. Stretch fabric graphics come pre-attached to the frame, making assembly easy and fast. Graphics adhere to the hubs using push-fit attachment technology. Kits come with graphics, frame and drawstring carry bag. Kits are available in 29 configurations.



Stretch push-fit fabric graphics come **pre-attached** to collapsible frame

features and benefits:

- NEW fabric popup display system
- Collapsible frame uses magnetic locking arms to remain standing
- Pre-attached stretch fabric graphics make set-up fast & easy
- Push-fit graphic connection technology
- 7 frame sizes and a variety of graphic styles to select from
- Optional lighting solution LUM-200 or LUM-LED-200 available (excluding Pyramid kits)
- Lifetime limited hardware warranty against manufacturer defects
- Comes in a drawstring carry bag

dimensions:

Hardware

Assembled unit:

Tabletop/2x2: 59.11" w x 59.42" h x 12.8" d
1501.37mm(w) x 1509.37mm(h) x 325mm(d)

1x3: 30.30" w x 88.23" h x 12.8" d
769.68mm(w) x 2241.06mm(h) x 325mm(d)

2x3: 59.11" w x 88.23" h x 12.8" h
1501.37mm(w) x 2241.06mm(h) x 325mm(d)

3x3: 87.92" w x 88.23" h x 12.8" d
2233.06mm(w) x 2241.0mm(h) x 325mm(d)

4x3: 116.72" w x 88.23" h x 12.8" d
2964.75mm(w) x 2241.06mm(h) x 325mm(d)

3-Quad: 83.51" w x 63.14" h x 12.8" d
2121.17mm(w) x 1603.78mm(h) x 325mm(d)

6-Quad: 124.25" w x 83.51" h x 12.8" d
3155.93mm(w) x 2121.17mm(h) x 325mm(d)

10-Quad: 164.99" w x 103.88" h x 12.8" d
4190.69mm(w) x 2638.55mm(h) x 325mm(d)

Graphics

See graphic templates for graphic sizes.

Please be sure to include a 2" bleed around perimeter. Refer to related graphic template for more information.

Shipping

Shipping dimensions:

Tabletop/2x2: 34.25" l x 10.24" w x 7.78" h
870mm(l) x 260mm(w) x 200mm(h)

1x3: 34.25" l x 10.24" w x 7.78" h
870mm(l) x 260mm(l) x 200mm(h)

2x3: 34.25" l x 10.24" w x 7.78" h
870mm(l) x 260mm(w) x 200mm(h)

3x3: 34.25" l x 10.24" w x 9.84" h
870mm(l) x 260mm(w) x 250mm(h)

4x3: 34.25" l x 12.2" w x 12.2" h
870mm(l) x 310mm(w) x 310mm(h)

3-Quad: 34.25" l x 10.24" w x 7.78" h
870mm(l) x 260mm(l) x 200mm(h)

6-Quad: 34.25" l x 10.24" w x 9.84" h
870mm(l) x 260mm(w) x 250mm(h)

10-Quad: 34.25" l x 12.2" w x 12.2" h
870mm(l) x 310mm(w) x 310mm(h)

Approximate shipping weight (includes hardware and carry bag only):

Tabletop/2x2: 7.5 lbs / 3.4 kgs

1x3: 6.7 lbs / 3.02 kgs

2x3: 9.7 lbs / 4.4 kgs

3x3: 13.12 lbs / 5.95 kgs

4x3: 17.15 lbs / 7.78 kgs

3-Quad: 6.6 lbs / 3 kgs

6-Quad: 10.58 lbs / 4.8 kgs

10-Quad: 15.9 lbs / 7.22 kgs

additional information:

- OCP shipping case available as optional upgrade
- Optional lighting solution LUM-200 or LUM-LED-200 available (excluding Pyramid kits)

We are continually improving and modifying our product range and reserve the right to vary the specifications without prior notice. All dimensions and weights quoted are approximate and we accept no responsibility for variance. E&OE. See Graphic Templates for graphic bleed specifications.

SETUP:

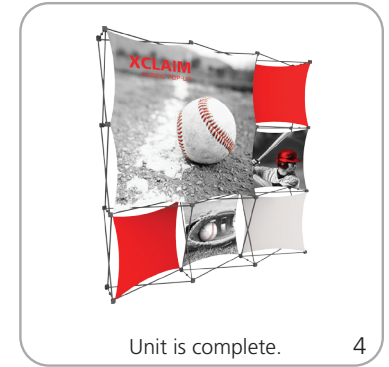
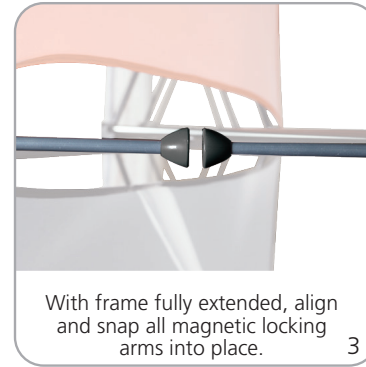
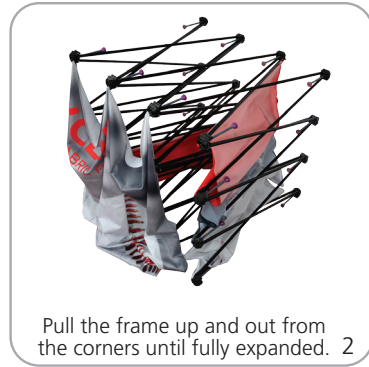

GRAPHIC RE-ATTACHMENT:



*Graphics come pre-attached to the frame. To re-attach graphics to frame follow the graphics style specific to the unit purchased.

*See graphic templates for graphic sizes.

XClaim 4x3 Kit 01 Display Graphic Style

IMPORTANT: Take a moment to review your display to understand front and rear connection points on the graphic styles in this kit. Typical graphic connections are shown to the right.

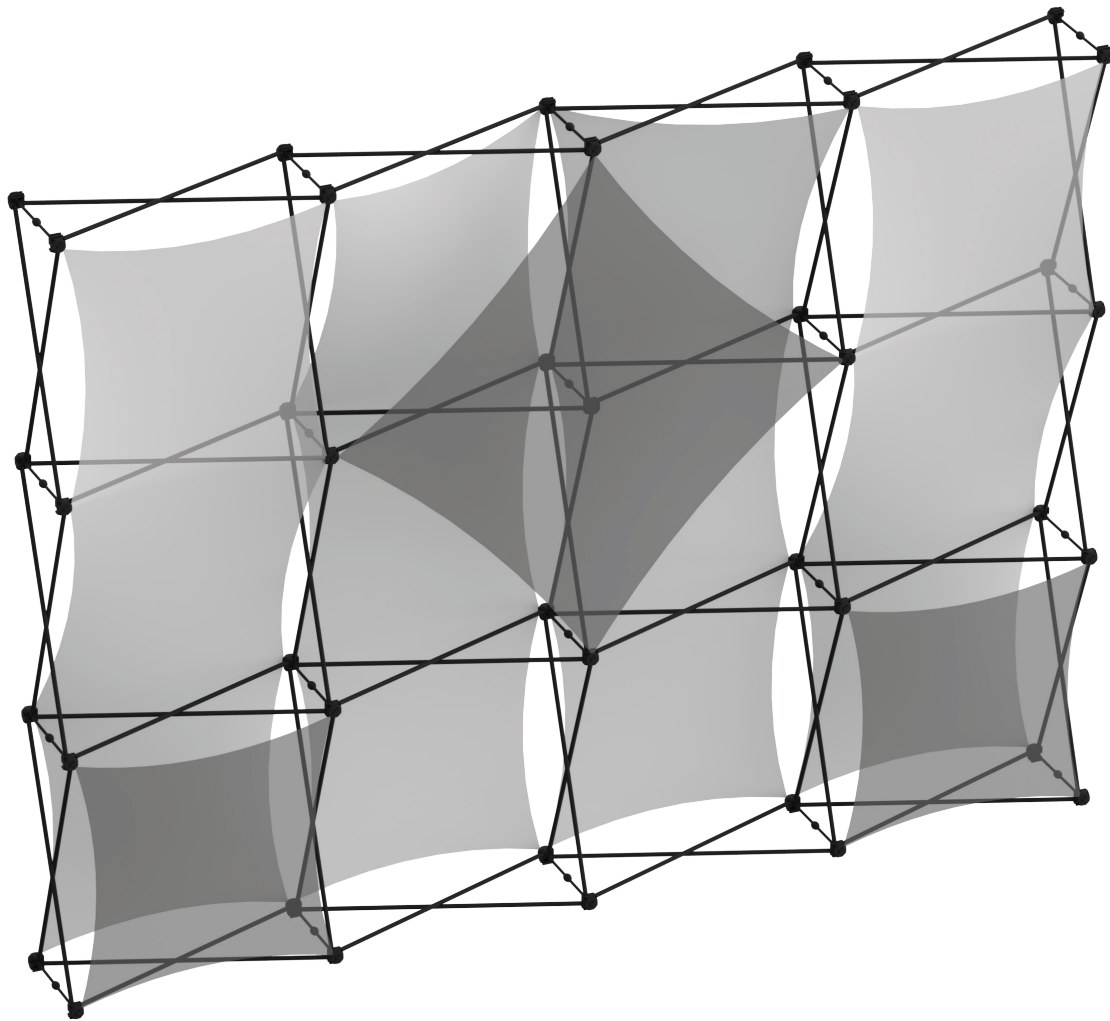

GRAPHIC CONNECTIONS

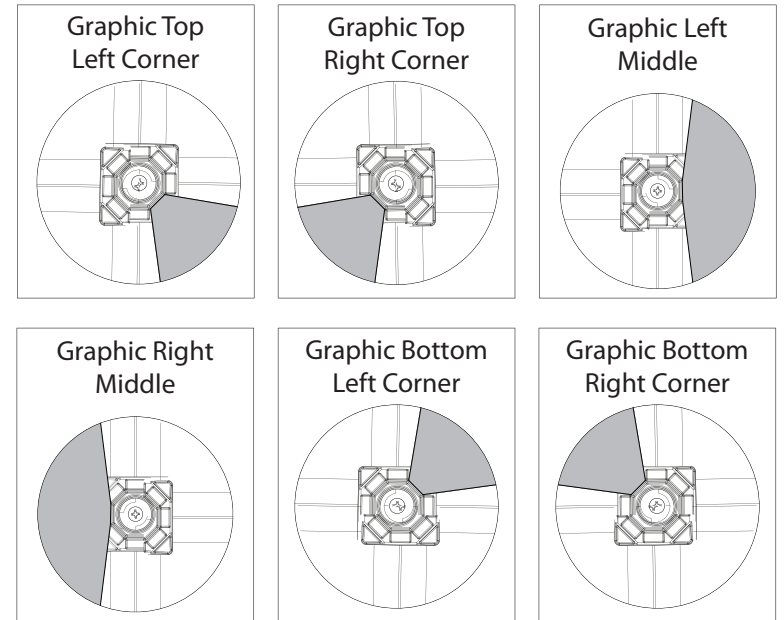

DIAMOND GRAPHIC CONNECTIONS

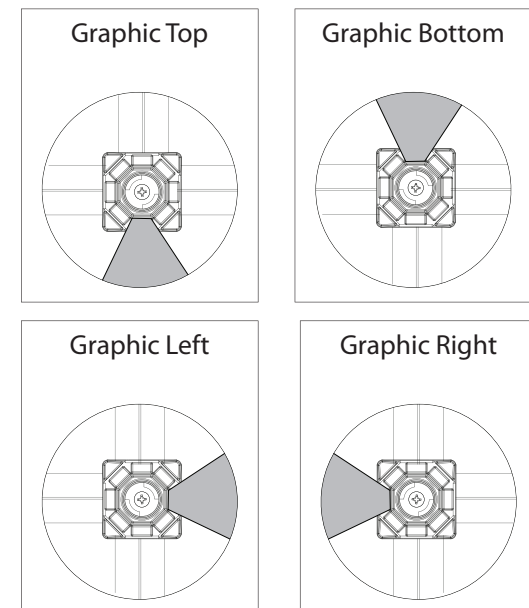

XClaim Displays



XCLM-2X2-K1



XCLM-2X2-K2



XCLM-2X2-K3



XCLM-2X2-K4



XCLM-1X3-K1



XCLM-1X3-K2



XCLM-1X3-K3



XCLM-1X3-K4



XCLM-2X3-K1



XCLM-2X3-K2



XCLM-3X3-K1

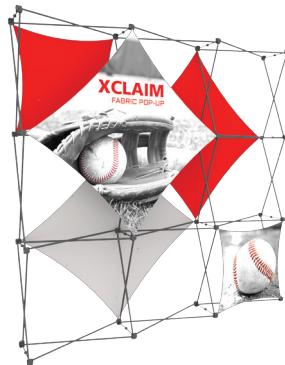

XCLM-3X3-K2



XCLM-3X3-K3



XCLM-3X3-K4

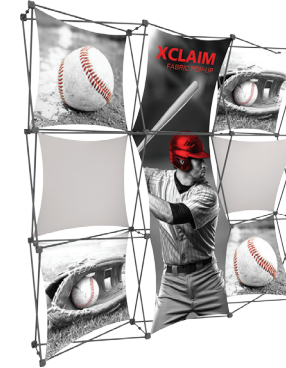

XCLM-3X3-K5

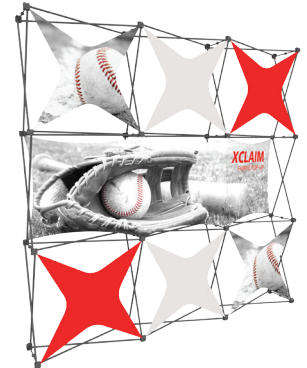

XCLM-3X3-K6

XClaim Displays



XCLM-4X3-K1

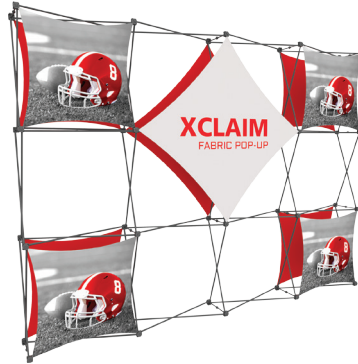

XCLM-4X3-K2



XCLM-4X3-K3

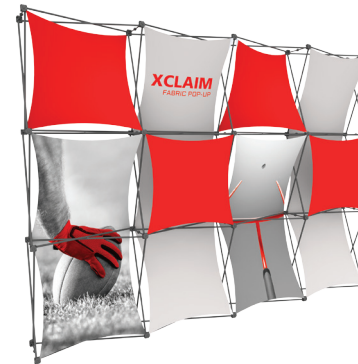

XCLM-4X3-K4



XCLM-4X3-K5



XCLM-4X3-K6



XCLM-3QP-K1

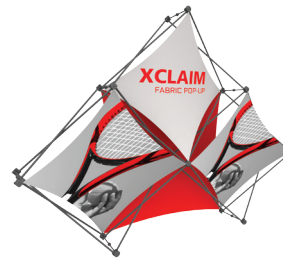

XCLM-3QP-K2



XCLM-6QP-K1

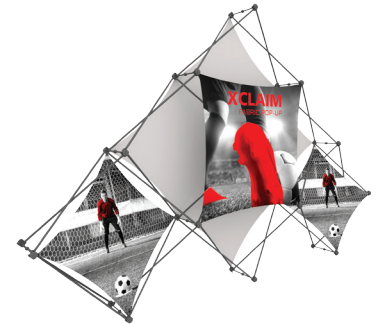

XCLM-6QP-K2



XCLM-10QP-K1



XCLM-10QP-K2



XCLM-10QP-K3